

Standardprodukter för informations- och
produktexponering för butik, kontor, mässor,
hemmiljö m.m

Produktkatalog 2009

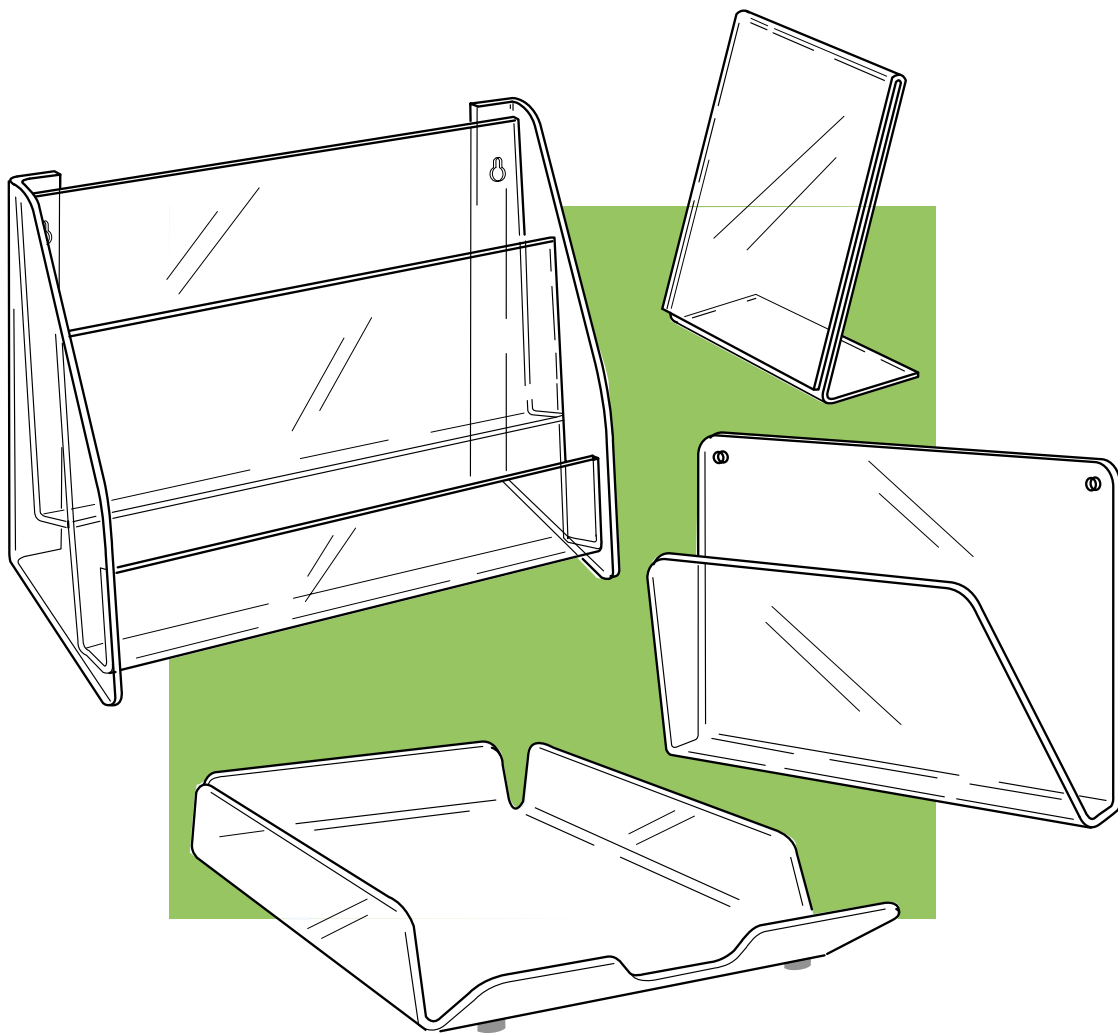

rexonic
SWEDEN

Rexonic i Piteå AB Verkstdsgatan 1 941 39 Piteå
Tel +46 (0)911 922 25 Fax +46 (0)911 92855
info@rexonic.se www.rexonic.se

displayer

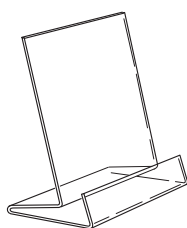

BORDSSTÄLL

STÄENDE	B	H	D	LIGGANDE	B	H	D		
E 1300	A3	300	390	200	E 1310	A3L	420	265	170
E 1400	A4	210	265	170	E 1410	A4L	300	190	140
E 1500	A5	150	190	140	E 1510	A5L	210	130	110
E 1600	A6	105	145	110	E 1651	A65L	210	90	110
E 1650	A65	100	190	140					
E 1700	A7	75	75	55					

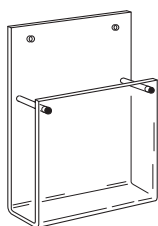
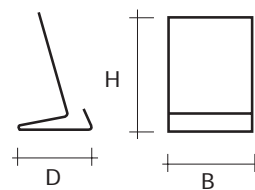

VÄGGSTÄLL

E 1401	A4	B 235, H 300, D 40
E 1501	A5	B 175, H 210, D 35
E 1601	A6	B 130, H 150, D 35
E 1651	A65	B 125, H 210, D 35
E 1701	A7	B 100, H 100, D 35

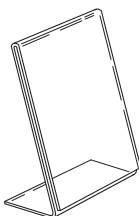
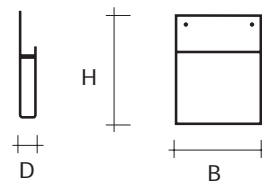

REKLAM & FOTOSTÄLL

STÄENDE	B	H	D	LIGGANDE	B	H	D		
R 1400	A4	210	305	90	R 1401	A4L	300	215	70
R 1500	A5	150	215	70	R 1501	A5L	210	155	60
R 1600	A6	105	155	60					
R 1700	A7	75	110	45					

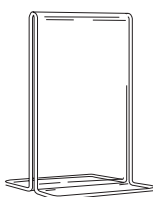
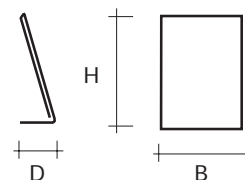

MENYSTÄLL

M 1400	A4	B 210, H 305, D 100
M 1500	A5	B 150, H 215, D 90
M 1600	A6	B 105, H 155, D 80
M 1650	A65	B 100, H 215, D 90
M 1700	A7	B 75, H 110, D 65

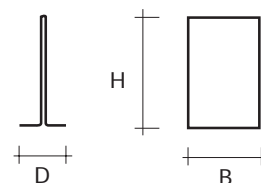

VISITKORTSSTÄLL

E 100 B 100, H 40, D 60

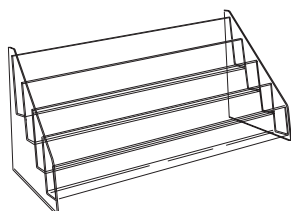
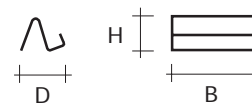

VISITKORTSSTÄLL

för 4-10 visitkort

E 110 B 205, H 75-135, D 70-150

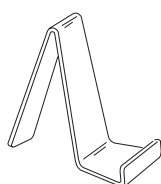
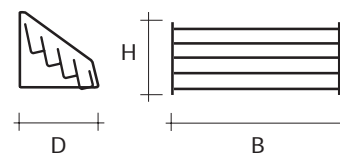

PRODUKTSTÄLL

E 200 B 50, H 130, D 110

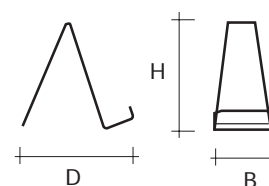

vägg- och bordsställ



B 1403 A4, alt. 2xA65
B 230, H 280, D 120

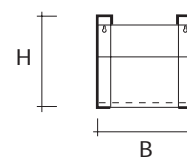
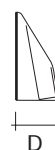

B 2403 2 x A4, Alt. 2 x 2 A65
B 230, H 280, D 120, A80

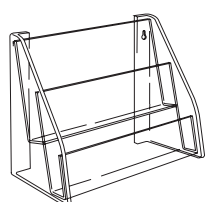
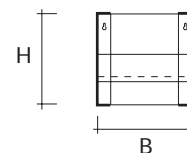

B 4403 2 x 2 A4, Alt. 2 x 4 A65
B 450, H 280, D 135, A80

Kan monteras på stativ TB 1003
(se sida)

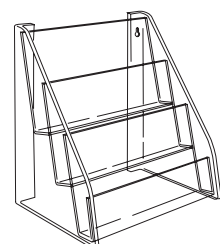
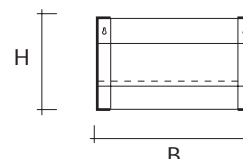

B 6403 3 x 2 A4, Alt. 3 x 4 A65
B 450, H 350, D 185, A80

Kan monteras på stativ TB 1003
(se sida)

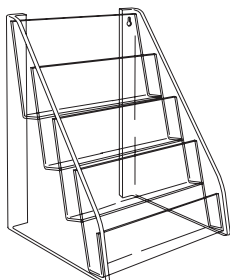
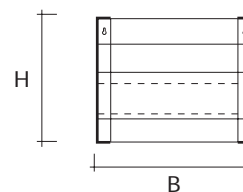

B 8403 4 x 2 A4, Alt. 4 x 4 A65
B 450, H 425, D 230, A80

Kan monteras på stativ TB 1003
(se sida)

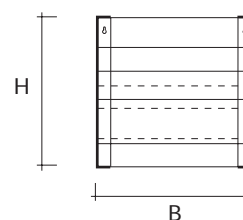

B 6503 3 x 2 A5, Alt. 3 x 3 A65
B 330, H 320, D 155, A80

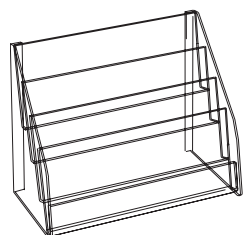
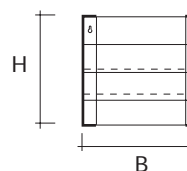

B 12503 4 x 3 A5, Alt. 4 x 4 A65
B 460, H 285, D 180, A45

Kan monteras på stativ TB 1003
(se sida)

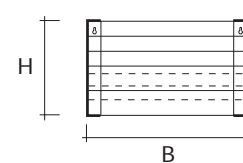

väggställ



V 1007 5 x 2 A7, B 165, H 400, D 45, A 70

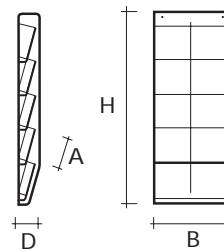

V 5401 5 x A4, B 250, H 720, D 10, A 90

V 5501 5 x A5, B 165, H 530, D 80, A 70

V 5701 5 x A65, B 120, H 500, D 75, A 70

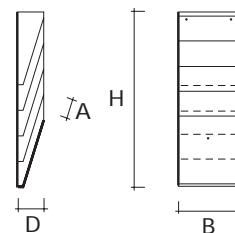

V 10401 10 x A4, B 250, H 180, D 10, A 90

V 10411 10 x A4L, B 330, H 880, D 80, A 70

V 10501 10 x A5, B 165, H 880, D 80, A 70

V 10701 5 x 2 A65, B 220, H 500, D 80, A 70

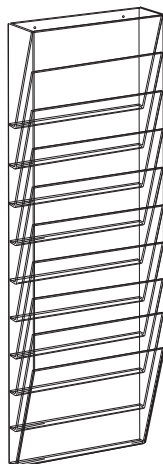
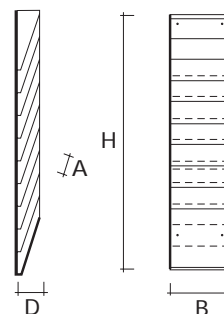

V 20401 10 x 2 A4, B 450, H 180, D 10, A90

V 20501 10 x 2 A5, B 325, H 880, D 80, A70

V 20701 10 x 2 A65, B 220, H 850, D 80, A70

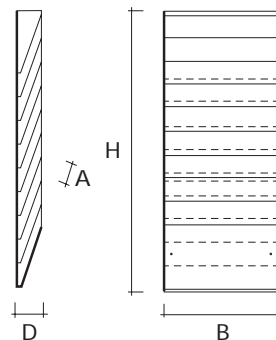

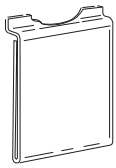

SKYLTHÅLLARE

AS 202 500 x 700 mm
 AS 203 A3 B 297 H 430 mm
 AS 204 A4 B 210 H 310 mm

AS 205 A5 B 150 H 220 mm
 AS 206 A6 B 105 H 160 mm
 AS 207 A7 B 75 H 110 mm

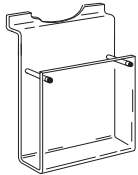
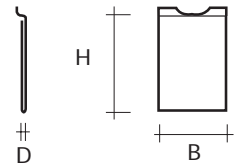

BROSCHYSTÄLL

AS 1405 A4 B 235 H 300 mm
 AS 1505 A5 B 175 H 210 mm

AS 1605 A6 B 130 H 150 mm
 AS 1655 A65 B 125 H 210 mm
 AS 1705 A7 B 100 H 105 mm

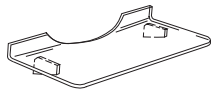
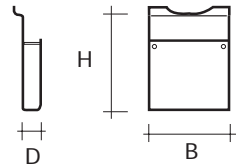

HYLLPLAN (Kan komb. med AS 310)

AS 300 300 x 140 mm



HYLLPLAN

AS 400 400 x 250 mm

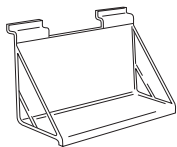

HYLLPLAN

AS 350 350 x 200 mm, med rygg och gavlar

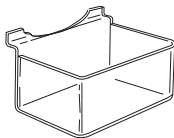
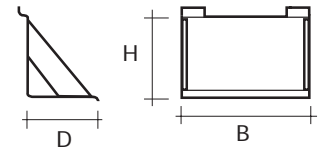

SKYLTLÅDA

AS 150 B 200 H 100 D 150 mm

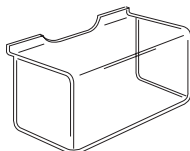
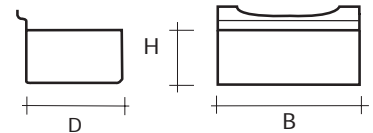

SKYLTHUV

AS 310 B 310 H 160 D 150 mm

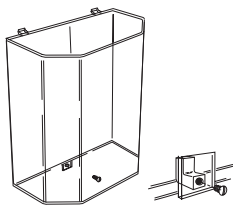
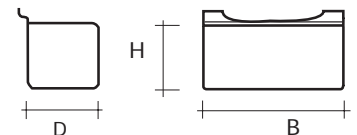

VITRINSKÅP

AS 500 B 400 H 385 D 180 mm

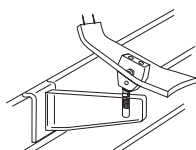
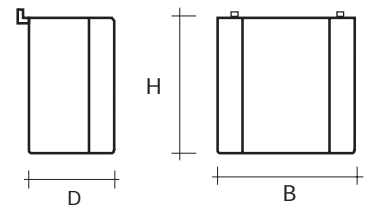

STÄLLBAR PRODUKTHÅLLARE

AS 25 B 70 H 75 D 100 -150 mm

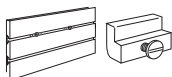
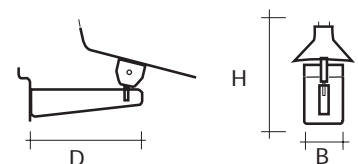

FÄSTERN FÖR SPÅRPANEL

AS 10 För montering av produkter med nyckelhål, affischskydd eller för övriga produkter

övriga produkter

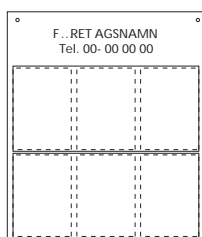

MÄKLARTAVLA

- K 600 2 x 3 A4, B 700, H 850, D 10
- K 900 3 x 3 A4, B 700, H 1 150, D 10
- K 1200 4 x 3 A4, B 700, H 1450, D 10

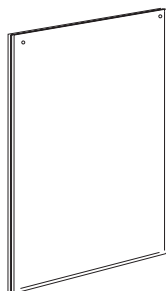
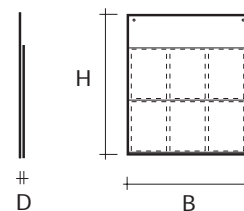

AFFISCHSKYDD

- A 7010 700 x 1000 mm, B 700, H 1020, D 2
- A 5070 500 x 700 mm, B 500, H 720, D 2
- A 3000 A3 B 297, H 430, D 2
- A 4000 A4 B 210, H 310, D 2

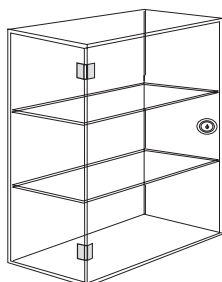
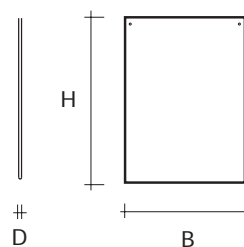

PRODUKSKÅP, låsbart

- P 340 B 340, H 470, D 200

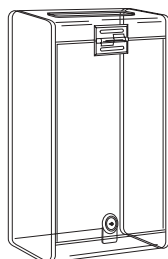
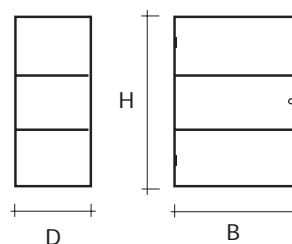

BREVLÅDA

- A 130 B 190, H 300, D 95

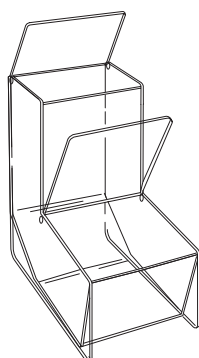
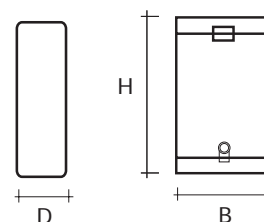

GODISAUTOMAT

- G 175 För bord eller spårpanel
B 175, H 300, D 255

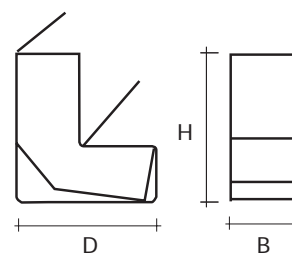

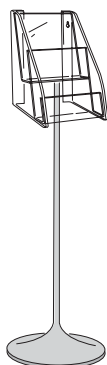

GOLVSTÄLL MINI

Bestående av Trumpetfot
Väggställ inkl. fästen.
Finns för A4 med 1-3 fack.
A5 2-6 fack.
Höjd ca. 950 mm.

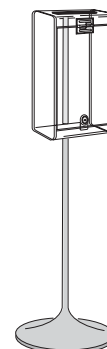

GOLVSTÄLL BREVLÅDA

Bestående av Trumpetfot och
transparent Brevlåda.
Höjd ca. 950 mm.



SNURRSTÄLL FÖR GOLV

Bestående av Trumpetfot och
Väggställ inkl. fästen
Finns för A4-A7 med 10-60 fack.
Kan förses med hjul.

Måttangivelsen avser ett snurr-
ställ med 40 fack A5

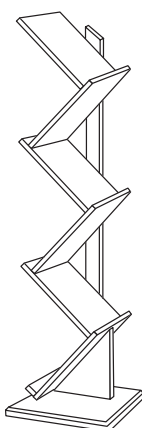
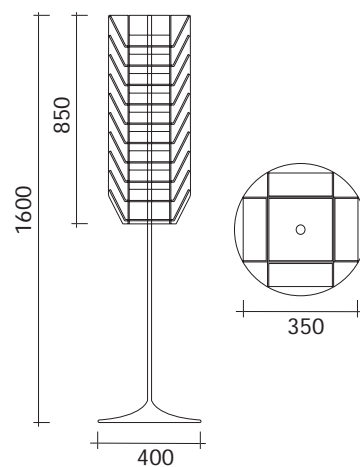

GOLVSTÄLL

ZIG ZAG 6 x A4
B 300, H 1500, D 420.

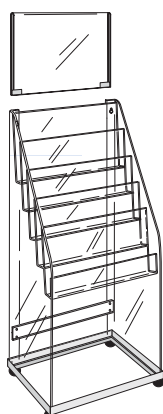

GOLVSTÄLL (Lev. omonterad)

Golvställ
G 9402 3 x 3 A4
B 680, H 1200, D 350, A 205
G 18402 6 x 3 A4
B 680, H 1460, D 350, A 130

Toppskylt
TG 3003 B 660, H 350
Skyltmått: B 660, H 250
Underrede
TG 3004

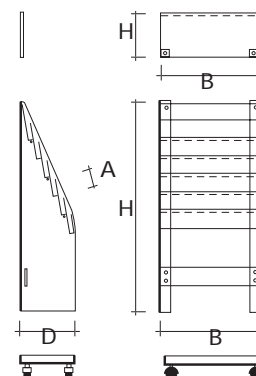

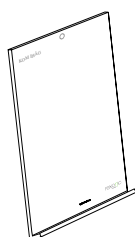

SKRIVTAVLA

Art nr Storlek Mått

MED TRYCK "KOM IHÅG"

210152 A5 B 140, H 190, D 16

410170 A4 B 210, H 265, D 16

HELT VITA UTAN TRYCK

210169 A5 B 140, H 190, D 16

410187 A4 B 210, H 265, D 16

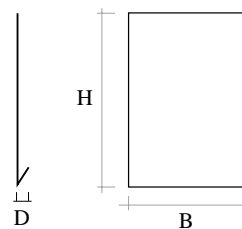

SKRIVBLOCKHÅLLARE

FÖR KYLSKÅP, VÄGG ELLER ANNAT

224807 A6 B 106, H 145

BORDSSTÅENDE PÅ FOT

224142 A6 B 106, H 145

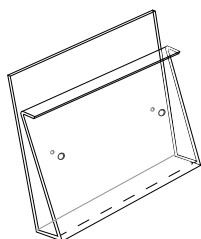
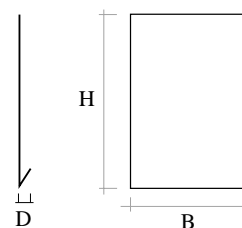

DOKUMENTHÅLLARE

MED DRAGHANDTAG, UTAN SARG

505159 A5 B 210, H 180

A4 B , H

MED DRAGHANDTAG OCH SARG

A5 B , H

505302 A4 B , H

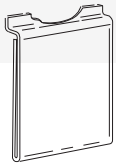

SKYLTHÅLLARE

AS 202	500 x 700 mm	AS 205	A5 B 150 H 220 mm
AS 203	A3 B 297 H 430 mm	AS 206	A6 B 105 H 160 mm
AS 204	A4 B 210 H 310 mm	AS 207	A7 B 75 H 110 mm

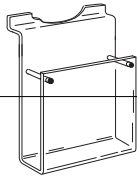
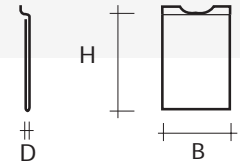

BROSCHYSTÄLL

		AS 1605	A6 B 130 H 150 mm
AS 1405	A4 B 235 H 300 mm	AS 1655	A65 B 125 H 210 mm
AS 1505	A5 B 175 H 210 mm	AS 1705	A7 B 100 H 105 mm

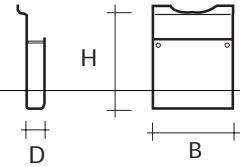

HYLLPLAN (Kan komb. med AS 310)

AS 300 300 x 140 mm



HYLLPLAN

AS 400 400 x 250 mm

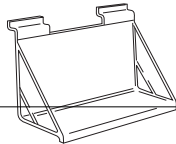

HYLLPLAN

AS 350 350 x 200 mm, med rygg och gavlar

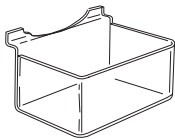
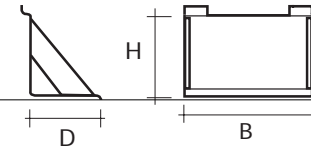

SKYLTLÅDA

AS 150 B 200 H 100 D 150 mm

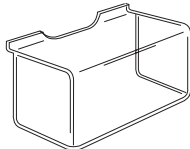
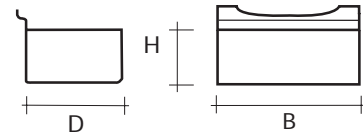

SKYLTHUV

AS 310 B 310 H 160 D 150 mm

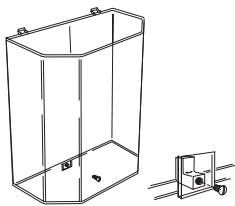
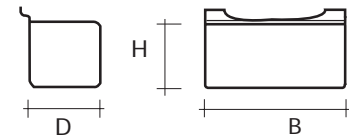

VITRINSKÅP

AS 500 B 400 H 385 D 180 mm

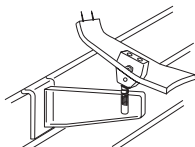
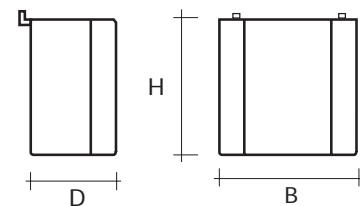

STÄLLBAR PRODUKTHÅLLARE

AS 25 B 70 H 75 D 100 -150 mm

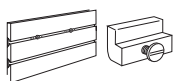
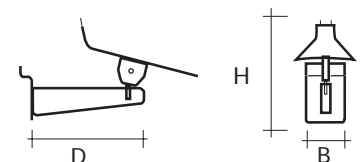

FÄSTEN FÖR SPÅRPANEL

AS 10 För montering av produkter med nyckelhål

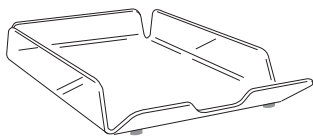

BREVKORG FÖR BORD (Stapelbar)

K 1400 A4 B 250, H 45, D 320

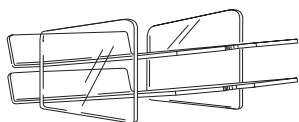
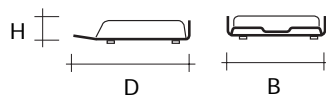

BREVKORG FÖR BORD

K 2400 2 x A4 B 250, H 145, D 340

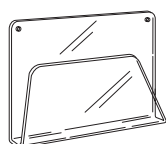
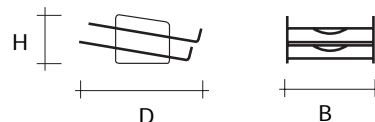

BREVKORG FÖR VÄGG

K 1411 A4L B 300, H 200, D 90

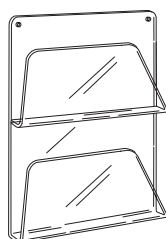
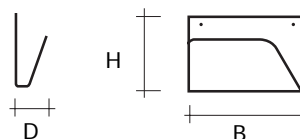

BREVKORG FÖR VÄGG

K 2411 2 x A4L B 300, H 450 D 90

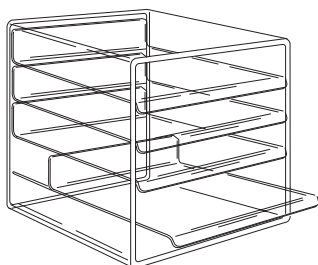
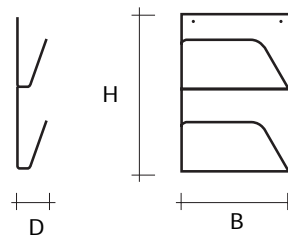

BREVKORG FÖR BORD

K 5400 5 x A4 B 250, H 250, D 320

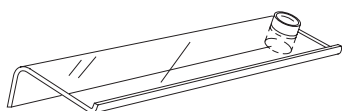
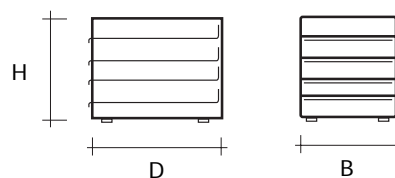

STÄLL FÖR ALMANACKA

K 100 B 600, H 35, D 120

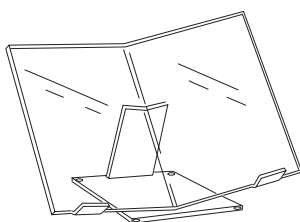
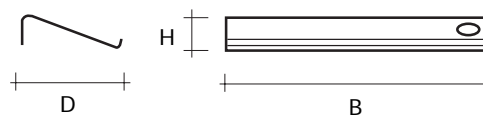

ALMANACKA/PÄRMSTÄLL

K 150 B 300, H 180, D 210

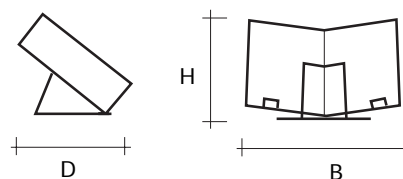

Har ni egna idéer
ring 0911-92225

rexonic
SWEDEN